

Metal distribution boxes for flush and surface mounting **3** YEAR WARRANTY

Technical data:

- Maximum insulation voltage: 690V; 50Hz
- Flame retardance: V-0
- IP code: IP40
- Colour: Gray
- Mounting type: Surface and flush



| Type | Number of poles | Module capacity (number of devices) | Dimensions (mm) | | | Packing / Box | Catalogue number |
|----------|-----------------|-------------------------------------|-----------------|-----|----|---------------|------------------|
| | | | H | L | W | | |
| MDB 1/4 | 1 | 4 | 251 | 190 | 90 | 1/10 | 600104 |
| MDB 1/8 | 1 | 8 | 251 | 262 | 90 | 1/10 | 600108 |
| MDB 1/12 | 1 | 12 | 251 | 334 | 90 | 1/10 | 600112 |
| MDB 1/16 | 1 | 16 | 251 | 406 | 90 | 1/10 | 600116 |



| Type | Number of poles | Module capacity (number of devices) | Dimensions (mm) | | | Packing / Box | Catalogue number |
|----------|-----------------|-------------------------------------|-----------------|-----|-----|---------------|------------------|
| | | | H | L | W | | |
| MDB 3/4 | 3 | 4 | 454 | 406 | 114 | 1/2 | 600304 |
| MDB 3/6 | 3 | 6 | 508 | 406 | 114 | 1/2 | 600306 |
| MDB 3/8 | 3 | 8 | 562 | 406 | 114 | 1/2 | 600308 |
| MDB 3/10 | 3 | 10 | 616 | 406 | 114 | 1/2 | 600310 |
| MDB 3/12 | 3 | 12 | 670 | 406 | 114 | 1/2 | 600312 |

Documents corresponding to the product:

Standard EN 62 208;
EN 60439-1; EN 60 439-3

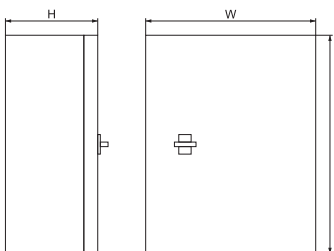

Stainless steel metal boards **3** YEAR WARRANTY

Supplied with a special lock, metal plate for fixing of electrical devices, lid for the input-output conductors, grounded dowel pin, gaskets, etc. Option to change the opening direction. Made of single stainless steel sheet. The mounting plate is treated with anti-corrosion and decorative powder coating. They are used in case of special requirements regarding the exposure of corrosion.

Technical data:

- Rated voltage: up to 1000V
- Maximum current: up to 800A
- Material: stainless steel
- IP code: IP 65

Mounting:

- vertically on flat surface



| Type | Thickness of metal sheet (mm) | Metal box dimensions (mm) | | | Packing / Box | Catalogue number |
|---------------|-------------------------------|---------------------------|-----------|-----------|---------------|------------------|
| | | L (height) | W (width) | H (depth) | | |
| SXF 25/25/15 | 1.0 | 250 | 250 | 150 | 1 | 54025 |
| SXF 30/25/15 | 1.0 | 300 | 250 | 150 | 1 | 54030 |
| SXF 40/30/20 | 1.0 | 400 | 300 | 200 | 1 | 54040 |
| SXF 50/40/20 | 1.2 | 500 | 400 | 200 | 1 | 54050 |
| SXF 60/40/20 | 1.2 | 600 | 400 | 200 | 1 | 54060 |
| SXF 70/50/20 | 1.2 | 700 | 500 | 200 | 1 | 54070 |
| SXF 80/60/25 | 1.5 | 800 | 600 | 250 | 1 | 54080 |
| SXF 100/80/30 | 1.5 | 1000 | 800 | 300 | 1 | 54100 |
| SXF 120/80/30 | 1.5 | 1200 | 800 | 300 | 1 | 54120 |

Documents corresponding to the product:

Standard EN 62208;
EN 60439-1; EN 60 439-3

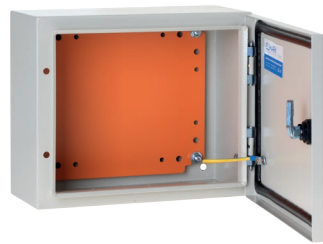

Metal distribution boards

3 YEAR WARRANTY

Supplied with a special lock, metal plate for fixing of electrical devices, lid for the input-output conductors, grounded dowel pin, gaskets, etc. Option to change the opening direction. Made of single steel sheet, treated with decorative powder coating.

Technical data:

- Rated voltage: up to 1000V
- Maximum current: up to 1250A
- Material: steel
- RAL 7032
- Coating: powder style painting
- IP code: IP 65

Mounting:

- vertically on flat surface

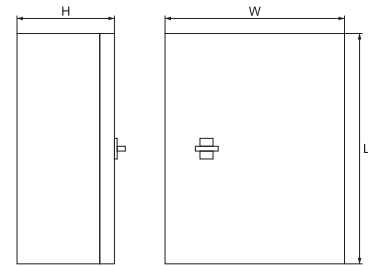
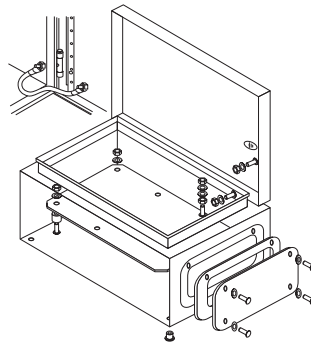

| Type | Thickness of metal sheet (mm) | Metal box dimensions (mm) | | | Nominal working current In (A) | Packing / Box | Catalogue number |
|-----------------|-------------------------------|---------------------------|-----------|-----------|--------------------------------|---------------|------------------|
| | | L (height) | W (width) | H (depth) | | | |
| JXF 25/25/15 | 1.0 | 250 | 250 | 150 | 80 | 1 | 53025 |
| JXF 25/30/15 | 1.0 | 250 | 300 | 150 | 100 | 1 | 53026 |
| JXF 30/25/15 | 1.0 | 300 | 250 | 150 | 100 | 1 | 53030 |
| JXF 30/40/20 | 1.0 | 300 | 400 | 200 | 160 | 1 | 53031 |
| JXF 40/30/20 | 1.0 | 400 | 300 | 200 | 160 | 1 | 53040 |
| JXF 40/50/20 | 1.2 | 400 | 500 | 200 | 250 | 1 | 53041 |
| JXF 40/40/20 | 1.2 | 400 | 400 | 200 | 250 | 1 | 53044 |
| JXF 50/40/20 | 1.2 | 500 | 400 | 200 | 250 | 1 | 53050 |
| JXF 40/60/20 | 1.2 | 400 | 600 | 200 | 250 | 1 | 53051 |
| JXF 60/40/20 | 1.2 | 600 | 400 | 200 | 250 | 1 | 53060 |
| JXF 60/60/20 | 1.2 | 600 | 600 | 200 | 250 | 1 | 53066 |
| JXF 70/50/20 | 1.2 | 700 | 500 | 200 | 350 | 1 | 53070 |
| JXF 80/60/25 | 1.5 | 800 | 600 | 250 | 400 | 1 | 53080 |
| JXF 100/80/30 | 1.5 | 1000 | 800 | 300 | 630 | 1 | 53100 |
| JXF 120/80/30 | 1.5 | 1200 | 800 | 300 | 630 | 1 | 53120 |
| JXF 140/80/30 | 1.5 | 1400 | 800 | 300 | 800 | 1 | 53140 |
| JXF 180/80/30 | 1.5 | 1800 | 800 | 300 | 1000 | 1 | 53188 |
| JXF 180/100/30* | 1.5 | 1800 | 1000 | 300 | 1250 | 1 | 53180 |

Note: *Metal boxes with double door

Plastic distribution boards

Documents corresponding to the product:

Standard EN 60439-1;
EN 60 439-3

Electric Switchboards with Type-Approval Certificates

The company has produced and successfully passed the type-approval procedures for the following metal and plastic electric control boxes and boards with ELMARK automation:

- Tower Mounted Switchgear
- Low Voltage Meter Box
- Low Voltage Main Switchboard
- Distribution Switchboard
- Power Compensation System



Low Voltage Meter Box Type TEPO

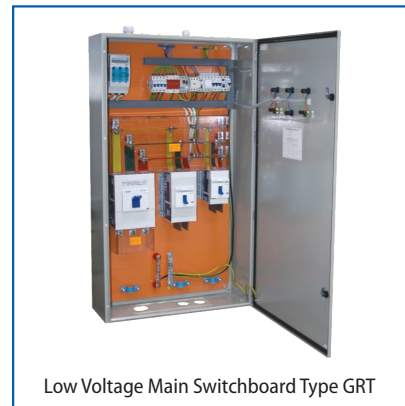
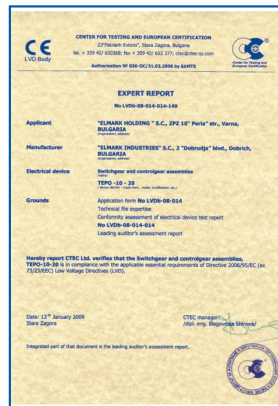

Low Voltage Main Switchboard Type GRT



Tower Mounted Switchgear Type MTT

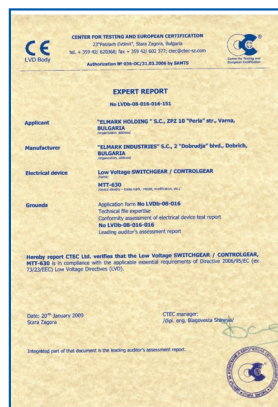

Power Compensation System Type CCU



Distribution Switchboard Type KRSH

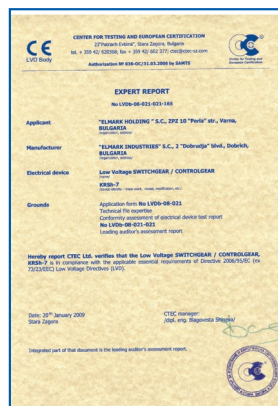



Documents corresponding to the product:

Standard EN 60439 -1
EN 60439 -5

Plastic distribution boards - ABS IP65

3 YEAR WARRANTY

Plastic distribution boards of various sizes. Intended for extension or distribution of cable lines. They can also be used as meter boxes. They are resistant to chemical agents, thermal and UV rays.

Technical Specifications:

- Resistance: chemical agents, weak acids, alkali, oils, salts, etc.
- Rated Voltage: up to 690V
- Maximum Current: up to 800A
- Thermal Deformation: over 240°C
- Operating Temperature: -35°C + 65°C
- Material: ABS
- IP code: IP65
- Colour: RAL7035 grey
- Recyclable
- adjustable mounting plate position

Mounting:

- Vertically on flat surface



ABS halogen free distribution boards - gray door

| Board Type | Material Type | L (mm) | W (mm) | H (mm) | Packing / Box | Catalogue number |
|------------|---------------|--------|--------|--------|---------------|-------------------|
| PP 3001 | ABS | 200 | 300 | 130 | 1 | 5312030130 |
| PP 3002 | ABS | 250 | 350 | 150 | 1 | 5312535150 |
| PP 3004 | ABS | 300 | 400 | 170 | 1 | 5313040170 |
| PP 3005 | ABS | 300 | 400 | 220 | 1 | 5313040220 |
| PP 3006 | ABS | 350 | 500 | 190 | 1 | 5313550190 |
| PP 3007 | ABS | 400 | 500 | 240 | 1 | 5314050240 |
| PP 3008 | ABS | 400 | 600 | 200 | 1 | 5314060190 |

Note: Open door angle 180°

ABS halogen free distribution boards - transparent door

| Board Type | Material Type | L (mm) | W (mm) | H (mm) | Packing / Box | Catalogue number |
|------------|---------------|--------|--------|--------|---------------|-------------------|
| PP 3011 | ABS | 200 | 300 | 130 | 1 | 5342030130 |
| PP 3012 | ABS | 250 | 350 | 150 | 1 | 5342535150 |
| PP 3014 | ABS | 300 | 400 | 170 | 1 | 5343040170 |
| PP 3015 | ABS | 300 | 400 | 220 | 1 | 5343040220 |
| PP 3016 | ABS | 350 | 500 | 190 | 1 | 5343550190 |
| PP 3017 | ABS | 400 | 500 | 240 | 1 | 5344050240 |
| PP 3018 | ABS | 400 | 600 | 200 | 1 | 5344060190 |
| PP 3020 | ABS | 500 | 700 | 250 | 1 | 5345070250 |





ABS halogen free distribution module boards - transparent door

| Board Type | Material Type | L (mm) | W (mm) | H (mm) | Packing / Box | Catalogue number |
|-------------------|---------------|--------|--------|--------|---------------|-------------------|
| PP 3112-18modules | ABS | 250 | 330 | 130 | 1 | 5322535150 |
| PP 3114-24modules | ABS | 300 | 350 | 150 | 1 | 5323040170 |
| PP 3116-45modules | ABS | 350 | 500 | 190 | 1 | 5323550190 |
| PP 3118-60modules | ABS | 400 | 600 | 200 | 1 | 5324060190 |

Note: Transparent door

Surface mounting polyester boards EC - IP65

3 YEAR WARRANTY

Technical Specifications:

- Colour: grey RAL 7035.
- IP65 protection degree.
- Material: made of halogen free reinforced fiberglass polyester, self-extinguishing V0 degree according to UL94.
- Double insulation, shock resistance: IK10, 20j, according to EN 62262.
- Application temperature: minimum -25°, maximum +65°.
- Resistance to abnormal heat (GWT)- board with blank door up to 960°C - board with transparent window up to 650°C.
- Application voltage 1000V, suitable for photovoltaic plants.
- Right or left reversible door with stainless steel pins – it can be opened more than 180°.
- Plain and smooth headboards for easy opening and conduit inlet.
- Removable frame ready to install slotted trunkings in the back.
- Back plates made up of metal or insulating material can be fixed directly to the board back, also if the frame is used, or can be adjusted to different heights through the kit EC625REG.
- Possibility to mount 48-75mm high switches or 102mm high switches starting from the board with dimensions 435x505x215.
- One-Screw-System: only one type of screws is used for the different accessories in order to permit a simple and easy assembly.
- Left or right reversible counter door with stainless steel pins, ergonomic handle, triangle lock, adjustable at two different heights with reference grid for the fixing of the devices.
- Fixing of the single/double blank or windowed panels through a ¼ turn screws.

Halogen free polyester boards EC- blank door

| Type | Material | L (mm) | W (mm) | H (mm) | Packing / Box | Catalogue number |
|-----------|-----------|--------|--------|--------|---------------|-------------------|
| PBBD 5001 | Polyester | 270 | 305 | 170 | 1 | 5332730170 |
| PBBD 5002 | Polyester | 325 | 430 | 185 | 1 | 5333243185 |
| PBBD 5003 | Polyester | 435 | 505 | 215 | 1 | 5334350215 |
| PBBD 5004 | Polyester | 435 | 655 | 215 | 1 | 5334365215 |
| PBBD 5005 | Polyester | 545 | 655 | 265 | 1 | 5335465265 |
| PBBD 5006 | Polyester | 620 | 810 | 320 | 1 | 5336281320 |

*Detailed installation instructions and information about the functions and applications of all additional accessories for polyester boxes, you can find on: www.elmarkholding.eu





Halogen free polyester boards EC - transparent door

| Type | Material | L (mm) | W (mm) | H (mm) | Packing / Box | Catalogue number |
|-----------|-----------|--------|--------|--------|---------------|-------------------|
| PBTD 5001 | Polyester | 270 | 305 | 170 | 1 | 5362730170 |
| PBTD 5002 | Polyester | 325 | 430 | 185 | 1 | 5363243185 |
| PBTD 5003 | Polyester | 435 | 505 | 215 | 1 | 5364350215 |
| PBTD 5004 | Polyester | 435 | 655 | 215 | 1 | 5364365215 |
| PBTD 5005 | Polyester | 545 | 655 | 265 | 1 | 5365465265 |
| PBTD 5006 | Polyester | 620 | 810 | 320 | 1 | 5366281320 |



Polyester hinger counterdoor EC

| Type | Material | Used for type boards | Packing / Box | Catalogue number |
|---------|-----------|----------------------|---------------|------------------|
| CD 5002 | Polyester | PBTD/PBBB 5002 | 1 | 53502CD |
| CD 5003 | Polyester | PBTD/PBBB 5003 | 1 | 53503CD |
| CD 5004 | Polyester | PBTD/PBBB 5004 | 1 | 53504CD |
| CD 5005 | Polyester | PBTD/PBBB 5005 | 1 | 53505CD |
| CD 5006 | Polyester | PBTD/PBBB 5006 | 1 | 53505CD |



Metal back plate EC

| Type | Dimensions | Used for type boards | Packing / Box | Catalogue number |
|---------|------------|----------------------|---------------|------------------|
| MP 5001 | 207x239 | PBTD/PBBB 5001 | 1 | 53501MP |
| MP 5002 | 264x364 | PBTD/PBBB 5002 | 1 | 53502MP |
| MP 5003 | 372x439 | PBTD/PBBB 5003 | 1 | 53503MP |
| MP 5004 | 372x589 | PBTD/PBBB 5004 | 1 | 53504MP |
| MP 5005 | 482x589 | PBTD/PBBB 5005 | 1 | 53505MP |
| MP 5006 | 556x739 | PBTD/PBBB 5006 | 1 | 53506MP |

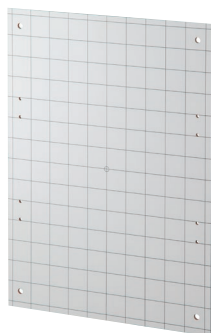

Insulating plastic back plate EC

| Type | Dimensions | Used for type boards | Packing / Box | Catalogue number |
|----------|------------|----------------------|---------------|------------------|
| IBP 5001 | 207x239 | PBTD/PBBB 5001 | 1 | 53501IBP |
| IBP5002 | 264x364 | PBTD/PBBB 5002 | 1 | 53502IBP |
| IBP5003 | 372x439 | PBTD/PBBB 5003 | 1 | 53503IBP |
| IBP 5004 | 372x589 | PBTD/PBBB 5004 | 1 | 53504IBP |
| IBP 5005 | 482x589 | PBTD/PBBB 5005 | 1 | 53505IBP |
| IBP 5006 | 556x739 | PBTD/PBBB 5006 | 1 | 53506IBP |

*Detailed installation instructions and information about the functions and applications of all additional accessories for polyester boxes, you can find on: www.elmarkholding.eu